

Panel System 300 PA, 300 PI & 300 PS (200 PA/PI, 150 PA/PI)

Wide Linear Strip & Curved Ceiling



Panel System 300 PA, 300 PI & 300 PS

Panel System 200 PA, 200 PI & 150 PA, 150 PI

Wide Linear Strip & Curved Ceiling

Wide panels with less joint lines, practical & versatile applications and 300 PS panels can be pre-curved to increase building headroom at atrium area. Consult "**Suckow & Fischer**" for design feasibility.



Panel System 300 PA (200 PA / 150 PA)

Panel System 300 PA wide linear strip ceiling is a lay-on plank system made of aluminium alloy. The most popular applications of the ceiling panels are installed from wall to wall as the concealed suspended ceiling for kitchens, bathrooms of the high-rise condominiums and for corridors of residential and commercial buildings. The panel is simply supported by wall perimeter trims without carriers within 2400mm panel length. The ceiling is concealed with a continuous outward flange on one side of the panel length, which is overlapped to the adjacent panel to prevent light and dust transmission from behind of the panels.

All ceiling panels are de-mountable without tools for easy maintenance. Also available in **Panel System 200 PA** and **150 PA** in width of 200mm and 150mm respectively. Three panel widths are having similar features and application possibilities.

The ceiling system is ideal for interior applications for kitchens, bathrooms and corridors of high-rise residential condominiums, hospitals, hotels, recreation clubs and commercial buildings.

Panel Carrier & Suspended System

For wall to wall installation of **Panel System 300 PA** with panel length not exceeding 2400mm, the ceiling panel is simply laid onto the wall perimeter trims without suspended carriers. For over 2400mm panel length, the installation has to add intermediate support of **PPI** carrier, made of 0.7mm thick galvanized steel, which is suspended by G.I. hanger rods to concrete soffit.

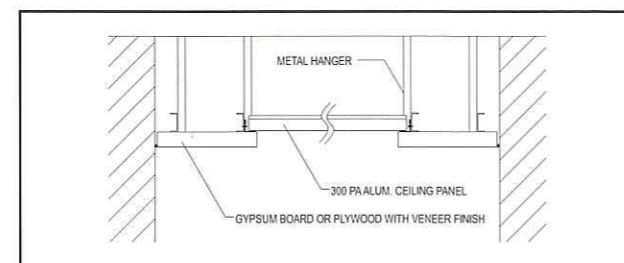
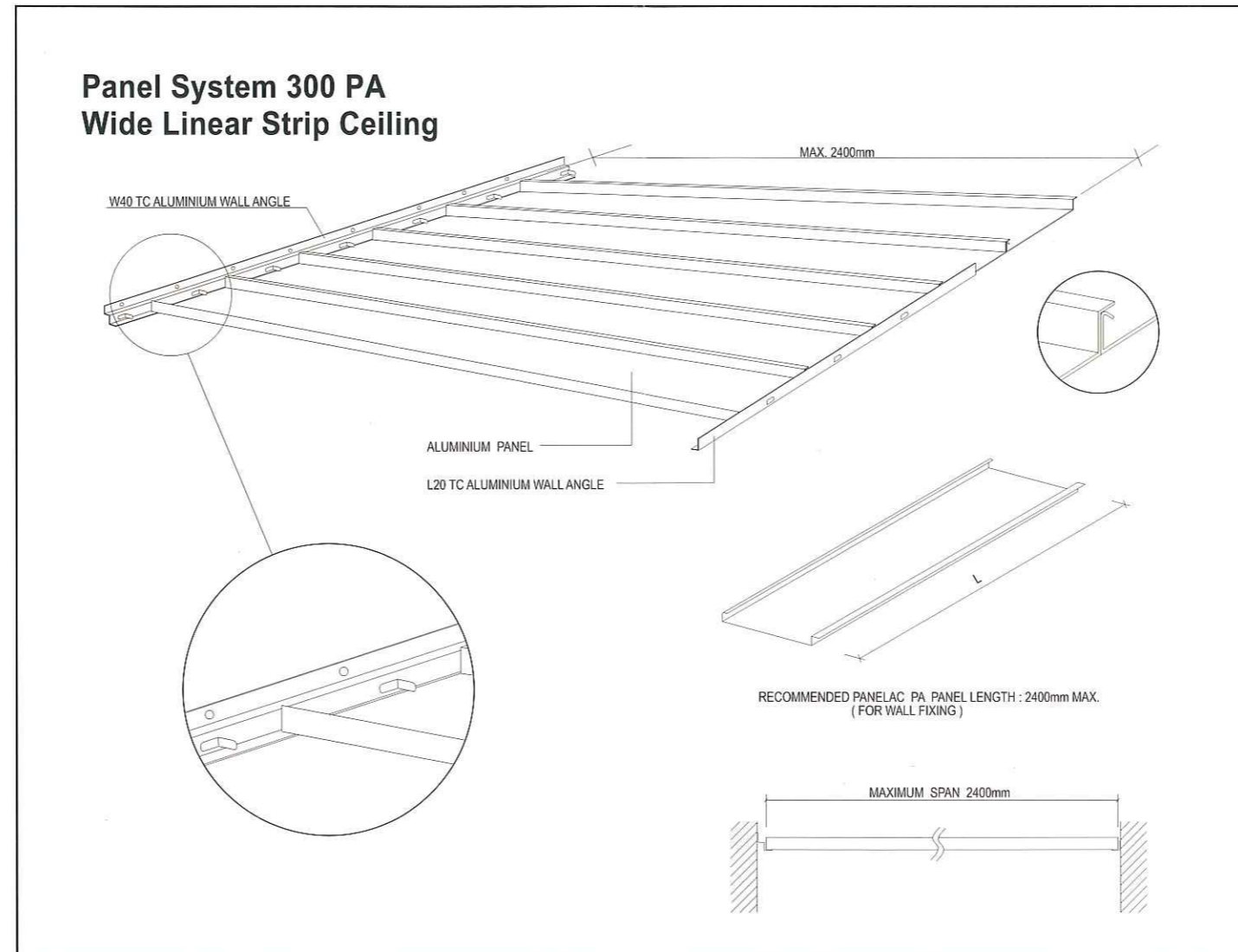
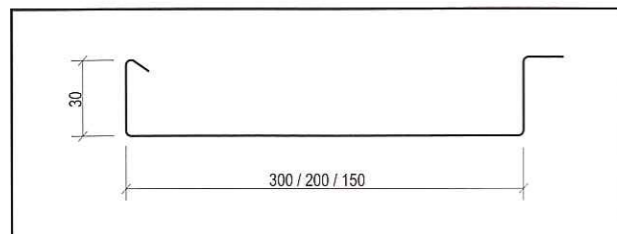

Materials

The standard strip ceiling panel in 300mm width is made of aluminium alloy coil coated in 0.7mm thick; for 200mm and 150mm width panels, the standard material is aluminium alloy coil coated in 0.6mm thick.

Finishes

Polyester stove-enamelled coil-coated finish on visible side is minimum 20 micron thick; non-visible side is 5 micron thick prime coated. Available in a range of standard colours.

Perforation & Acoustic

Perforation on panel is optional. Standard perforation patterns available are 1.8mm/2.0mm diameter holes, in staggered pattern with approximate 20% open area. Acoustic black fleece is laid on panel back for sound absorption or choice of using other insulation inlay for heat & sound absorption is upon request.

Fabrication Process

Continuous cold rolling technique is applied to form ceiling panel to the required shape.

Panel Length

Roll-form in panel length from 1000mm to 5800mm.

Upstand at Panel Ends

Ceiling panels can be fabricated with upstands at the panel ends upon request.



Panel System 300 PI Wide Linear Strip & Curved Ceiling

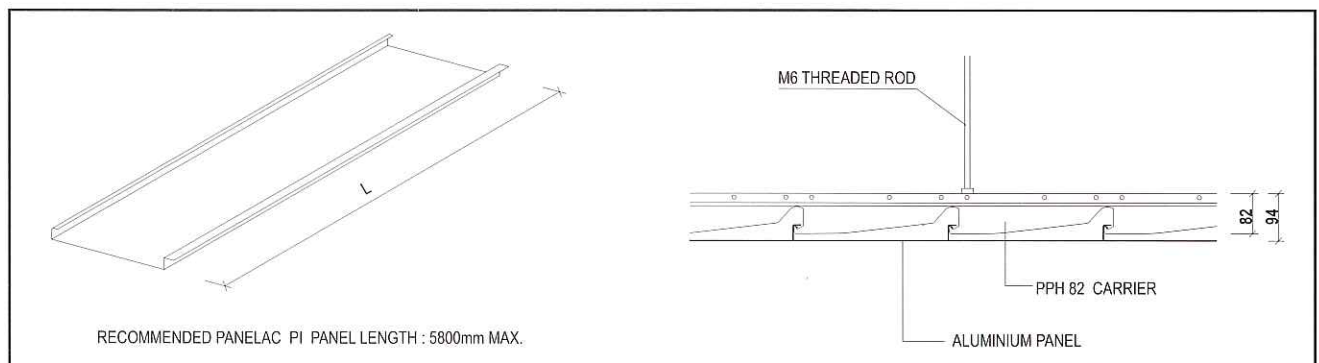
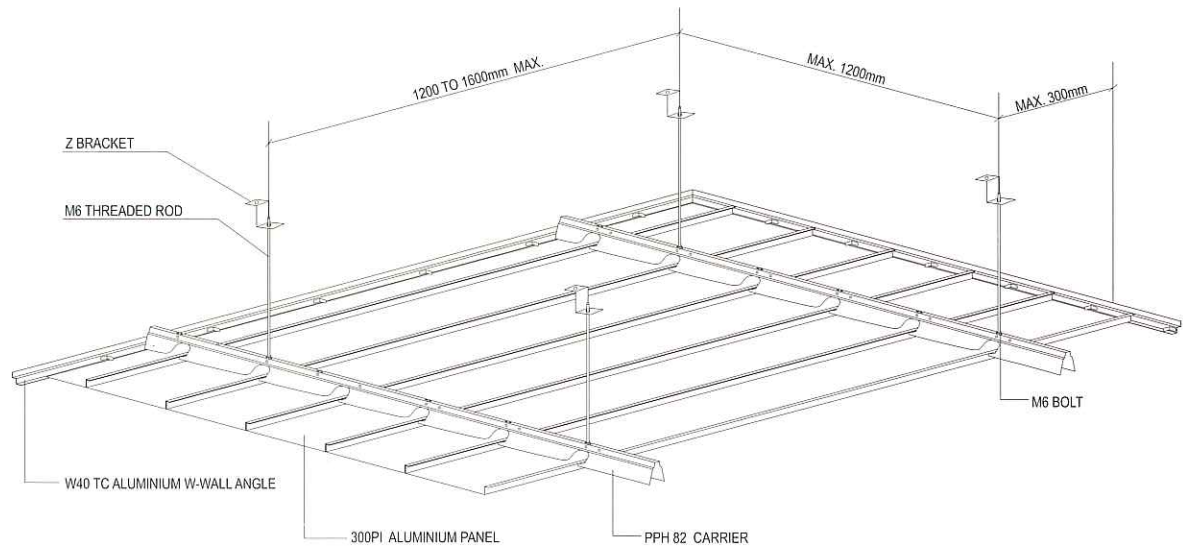

Panel System 300 PI (200 PI / 150 PI)

Panel System 300 PI wide linear strip ceiling is a hook-on plank system made of aluminium alloy. The ceiling is concealed type with a continuous outward flange on one side of the panel length, which is overlapped to the adjacent panel to prevent light and dust transmission from behind of the panel. The system is suitable for interior ceiling design with long panel length up to 5800mm. The panel is suspended by proprietary carriers and individual panel is de-mountable from the carriers. Also available in **Panel System 200 PI** and **150 PI** in width of 200mm and 150mm respectively.

Panel Carrier & Suspended System

The 300 PI panel is hook onto **PPI** carrier, made of 0.7mm thick galvanized steel coated in black finish. Standard length of the carrier is in 4000mm length, which is suspended by G.I. hanger rods to concrete soffit. The carrier span is

maximum 1600mm c/c and distance between suspensions is maximum 1200mm/c.

Advantages of Panel System 300 PA & 300 PI Wide Linear Strip Ceiling

- Economical wall to wall ceiling installation without carriers.
- Ideal ceiling solutions for kitchens, bathrooms and corridors.
- Simple & economical suspension system.
- Colour consistency with coil coated material.
- Dimensionally stable; fabrication with roll-forming dies.
- Flexible in panel length up to 5800mm.
- Low maintenance; dismantle individual panel possible.

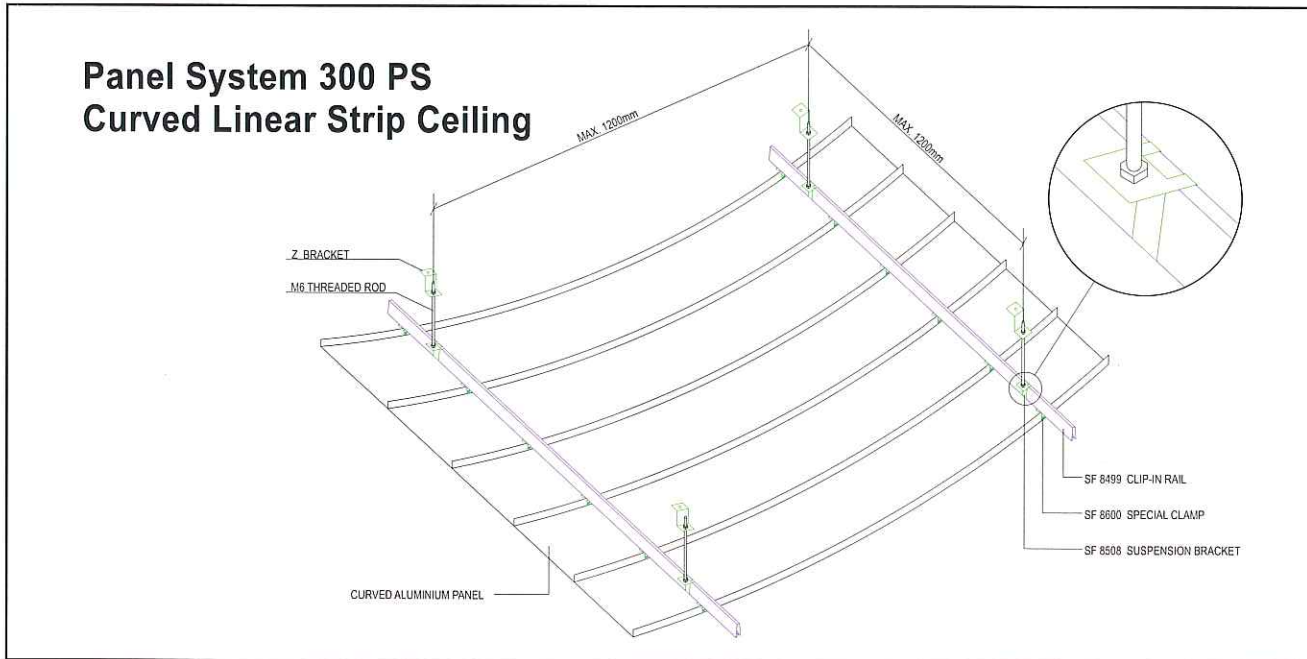

Panel System 300 PS Curved Linear Strip Ceiling

Panel System 300 PS curved linear strip ceiling panels is a concealed grid system in standard width of 300mm. The curved strip ceiling is fabricated and factory pre-curved by roll-forming process. The special design of curved ceiling is for interior applications and is suitable for lift lobbies and atrium areas of commercial and residential buildings. The system is easily dismantling for maintenance.

Panel Carrier & Suspended System

The 300 PS panel is wedged into **SF 8600** special clamp, which is inserted into clip-in rail, **SF 8499**, at 300mm intervals. There are pre-punched pips along the panel length to hold the panel at the special clamp. The clip-in rail is made of 0.5mm thick galvanized steel in standard length of 4000mm, which is suspended by suspension bracket, **SF 8508**, with G.I. hanger rods or thread rods to concrete soffit. The carrier span is maximum 1200mm c/c and distance between suspensions is maximum 1200mm/c.

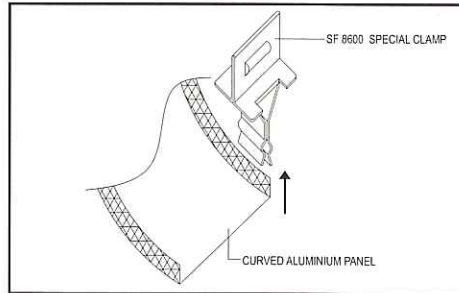

Panel Dimensions

Standard panel width	: 300mm
Standard Panel thickness	: 0.7mm
Panel length	: 1000 to 5800mm

Panel Radius

Concave Radius	: 1000mm Minimum
Convex Radius	: 750mm Minimum



Advantages of Panel System 300 PS Curved Linear Strip Ceiling

- Economical true curved ceiling solution.
- Choice of concave or convex panel shape.
- Simple & economical suspension system.
- Colour consistence with coil coated material.
- Dimensionally stable; fabrication with roll-forming dies.
- Low maintenance; dismantle individual panel possible.

Accessories

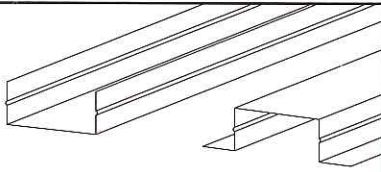

NUXUS T100 FF GRID
20 x 40 x 0.6mm
100mm WIDE, 3000mm LONG

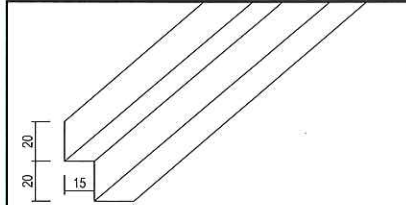

Z40 ALUM. W-WALL ANGLE
20 x 15 x 20 x 20 x 0.7mm
3000mm LONG

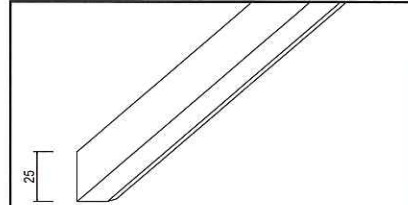

L20 ALUM. L-WALL ANGLE
25 x 20 x 0.7mm
3000mm LONG

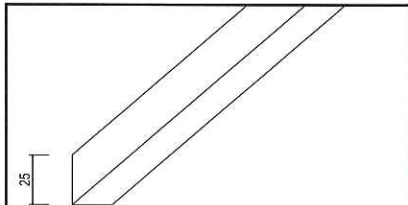

C25 ALUM. L-WALL ANGLE
25 x 20 x 0.7mm
3000mm LONG

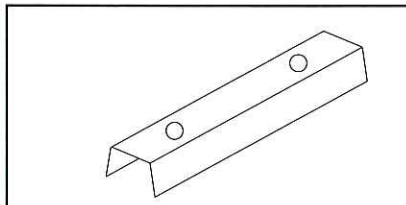

RPH CARRIER CONNECTOR
150mm LONG

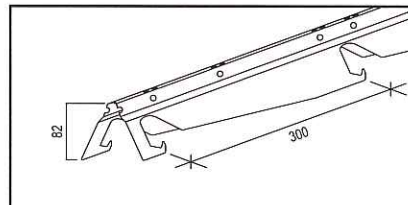

PPH 82 STEEL CARRIER
82mm (H) x 0.7mm THICK
3900mm LONG

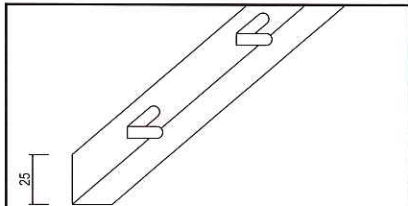

L20 TC ALUM. L-WALL ANGLE
25 x 20 x 0.7mm
3000mm LONG

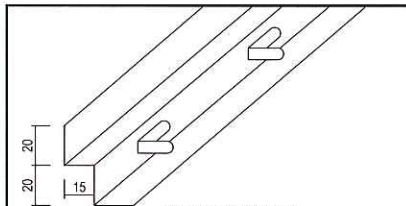

W40 TC ALUM. W-WALL ANGLE
20 x 15 x 20 x 20 x 0.7mm
3000mm LONG

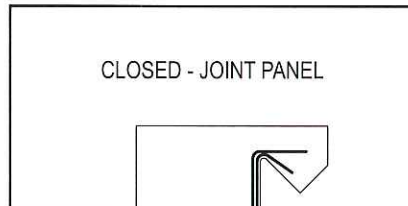

CLOSED - JOINT PANEL



acoustic
VISION

Distributed by:

Acoustic Vision

17 - 19 Podmore Street

Dandenong, VIC 3175 Australia

Tel +61 3 9769 7212

Fax +61 3 9769 7222

W www.acousticvision.com.au

E sales@acousticvision.com.au